

aerospace
climate control
electromechanical
filtration
fluid & gas handling
hydraulics
pneumatics
process control
sealing & shielding



Parker Automation Controller

Integrated Machine Control, Multi-Axis Motion, and Visualization



ENGINEERING YOUR SUCCESS.

Parker Hannifin

The global leader in motion and control technologies

A world class player on the local stage

Global Product Design

Parker Hannifin has more than 40 years experience in the design and manufacturing of drives, controls, motors and mechanical products. With dedicated global product development teams, Parker draws on industry-leading technological leadership and experience from engineering teams in Europe, North America and Asia.

Local Application Expertise

Parker has local engineering resources committed to adapting and applying our current products and technologies to best fit our customers' needs.

Manufacturing to Meet Our Customers' Needs

Parker is committed to meeting the increasing service demands that our customers require to succeed in the global industrial market. Parker's manufacturing teams seek continuous improvement through the implementation of lean manufacturing methods throughout the process. We measure ourselves on meeting our customers' expectations of quality and delivery, not just our own. In order to meet these expectations, Parker operates and continues to invest in our manufacturing facilities in Europe, North America and Asia.

Local Manufacturing and Support

Parker provides sales assistance and local technical support through a network of dedicated sales teams and authorized technical distributors throughout

Cleveland, OH - Corporate Headquarters



Rohnert Park, CA - Electronics Business Unit and Headquarters for Electromechanical NA.

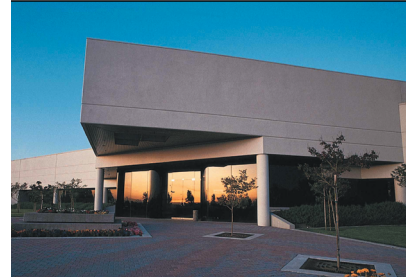

Parker Electromechanical's Worldwide Manufacturing Locations

North America

- Rohnert Park, CA
- Irwin, PA
- New Ulm, MN
- Wadsworth, OH
- Charlotte, NC

Europe

- Littlehampton, UK
- Dijon, France
- Offenburg, Germany
- Filderstadt, Germany
- Milan, Italy

Asia

- Wuxi, China
- Hwaseong-si, Korea
- Chennai, India

Irwin, PA - Mechanics Business Unit and manufacturing.



New Ulm, MN - Motor and Gearhead Business Unit and manufacturing.



Wadsworth, OH - Industrial Profile Systems manufacturing.



North American and around the globe. For contact information, please refer to the sales offices on the back cover of this document or visit www.parker.com

Parker Automation Controller - PAC

Powerful, integrated, and designed for the global machine market, the Parker Automation Controller (PAC) provides OEMs with a standards-based automation solution designed to tackle the most demanding applications. The PAC consolidates advanced logic, multi-axis motion, signal handling, and web-published visualization into one performance driven solution, thus eliminating the need for unnecessary hardware and communication links, and increasing developer efficiency.

The PAC employs the industry-leading EtherCAT communication protocol for motion, I/O, and third-party device connectivity, and combined with the Parker Automation Manager IDE for application development, the PAC provides OEMs with an engineered solution for the most demanding applications; a single, intuitive environment for application development; industry standard programming; machine-to-machine communication; network separation; and even Intellectual Property (IP) protection methods among other features.

With the standard dual LAN capability for network separation,



built-in OPC Server, Modbus TCP functionality, and the ability to integrate directly into Ethernet/IP and Profinet networks, the PAC provides unprecedented connectivity for complimentary devices *and* network isolation for IT professionals.

The solid state design is precisely engineered for demanding industrial environments. The powerful, yet energy efficient Intel® Atom™ processor allows for fanless operation while supporting

dual-cores, 64-bit instructions, and Hyperthreading technology. Coupled with the removable, solid state SD storage media, all moving parts have been eliminated for a robust, industrial grade control solution.

Hardware

- Intel Atom Dual-core, 1.60GHz, 64-bit
- 1GB DDR3 SDRAM
- Fan-less
- SD Application Memory
- Local & Remote I/O
- DIN Rail Mounting

Software

- IEC61131-3 Programming
- PLCopen Motion Control
- DIN 66025 CNC G-code
- Simulation Runtime Engine
- Web-configuration Tool
- Custom Libraries
- Extensible, Reusable Code

Communications

- EtherCAT
- Ethernet/IP
- Profinet
- Profibus
- OPC Server
- Modbus TCP
- Dual LANs

Parker Automation Controller - PAC

Hardware Features

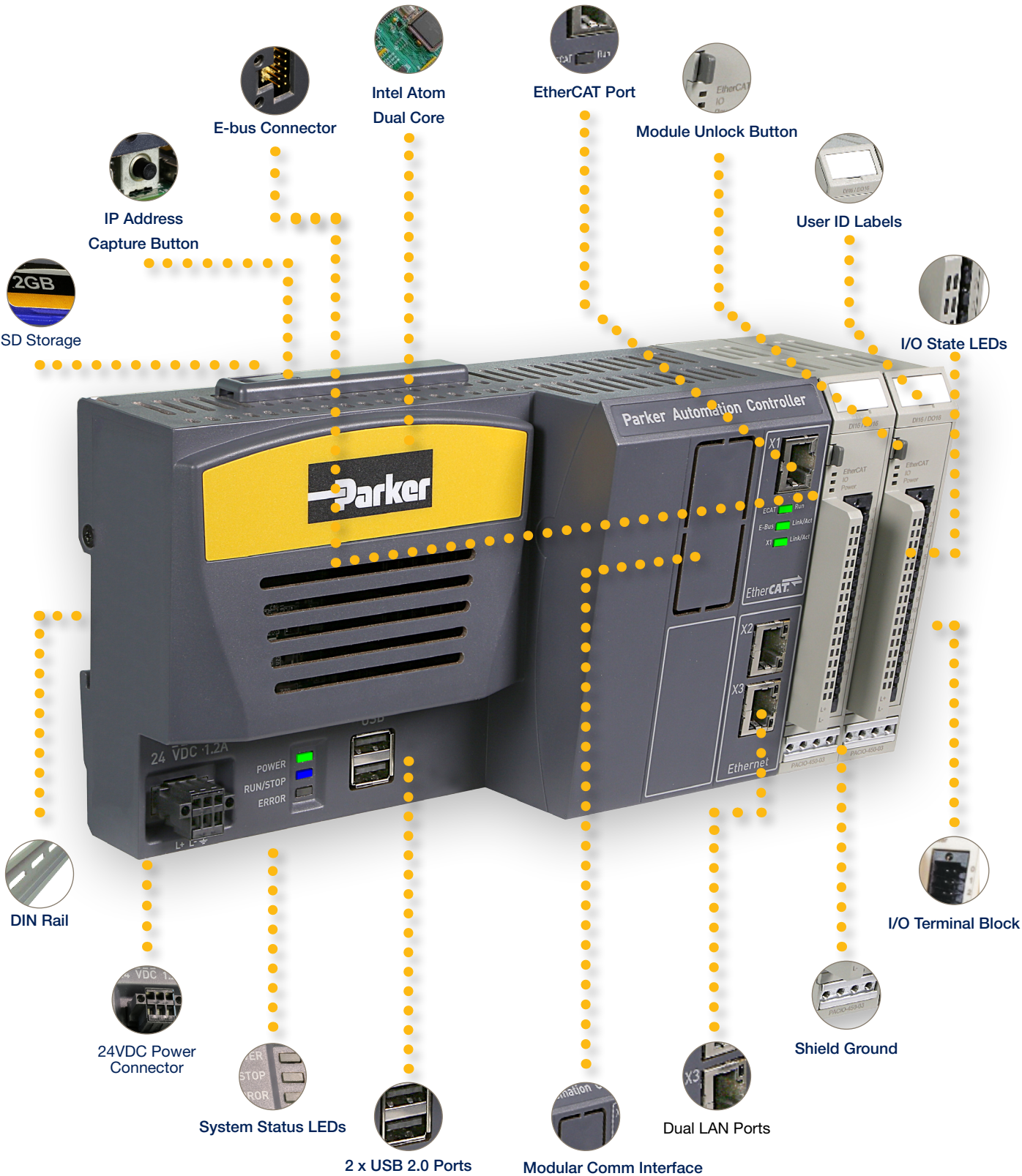

Parker Automation Controller - PAC

PAC Specifications

Processor	Intel® Atom CPU, 1.6 GHz, Dual Core, 64bit, 1 MB L2 Cache
Memory	Up to 1GB DDR3 SDRAM, 1066 MHz, PC3-8500, 204-pin SODIMM Socket
Storage	2GB Secure Digital Card (SD)
Retentive Memory	256kB, 512kB
BIOS	Insyde H ₂ O
Input Voltage	24 VDC (-15 %/+25 %), SELV, 1.2A, 29W, Req. Class 2 Power Source, Overvoltage Cat. 1
Fuse	Littelfuse Nano SMF Slow Blow Type -- Littelfuse Part Number R454002
Shock Rating	10g peak, 11ms (operating); 30g peak, 11ms (non-operating)
Operating Vibration	10-500Hz: 2grms random
Altitude	10,000 ft. (3048m)
Relative Humidity	0% to 95% non-condensing
Operating Temperature	32 to 122 °F (0-50 °C) Ambient
Storage Temperature	-13 to 158 °F (-25 to 70 °C)
Environmental	IP20, RoHS Compliant
Heat Dissipation	5.0 W max. w/o optional communications module, 5.8 W maximum w/ optional module
Weight	1.45 lbs (0.66kgs) w/o optional comm. module; 1.65 lbs (0.75kgs) w/ optional module
Dimensions	3.27"H x 4.93"W x 8.02"L w/o optional comm. module; 3.53"H w/ optional module
Mounting	35 mm DIN rail (top-hat rail)
Ports	2x RJ-45 10/100/1000BaseT Ethernet; 1x RJ45 100Mbit/s EtherCAT supporting IEEE1588 distributed clocks; 2 x USB 2.0 Host Type A

PAC Standards and Conformance

Tests	Specification
Harmonic Current Emissions	EN 61000-3-2:2006 + A2:2009, IEC 61000-3-2:2009
Voltage Fluctuations and Flicker	EN 61000-3-3:2008, IEC 61000-3-3:2008
Electrostatic Discharge Immunity	IEC 61000-4-2:2008
Radiated Electromagnetic Field Immunity	IEC 61000-4-3:2010
Electrical Fast Transient Burst Immunity	IEC 61000-4-4:2012
Surge Immunity	IEC 61000-4-5:2005
Radio Frequency Common Mode Immunity	IEC 61000-4-6:2008
Power Frequency Magnetic Field Immunity	IEC 61000-4-8:2009
Voltage Interrupts Immunity	IEC 61000-4-11:2004
Radiated & Conducted Emissions	EN 55011:2009 + A1:2010
CISPR 11 Group 1, Class A	CISPR 11:2009 + A1:2010
†† Part 1 General Requirements	EN61010-1:2010
†† Part 2-201 Particular Requirements for Control Equipment	EN61010-2-201:2013
‡Part 1: General Requirements	UL 61010-1, 3rd Edition, 2012-04-17
‡Part 1: General Requirements	CAN/CSA-C22.2 No. 61010-1, 3rd Ed, 2012-04
†† Part 2-201: Particular requirements for control equipment	UL 61010-2-201
Protection Degree IP20	IEC 60529, Ed 2.1+CORRs. 1:2003, 2:2007, 3:2009

†Safety Requirements ‡Electrical Equipment for Measurement, Control and Laboratory use.

Parker Automation Controller - PAC

PAC I/O

The PAC I/O System comprises a variety of modules for digital, analog and temperature signals as well as communication interfaces. The modules connect directly to the controller via the built-in EtherCAT bus for local architectures and are extended to remote locations via the extender and bus coupler modules, thus supporting both local and distributed I/O architectures.

PAC I/O modules feature a removable cage-clamp terminal design which provides for easy wiring and assembly and allows for the removal and insertion of modules without interfering with

wiring; LED status indicators for the EtherCAT bus, I/O, power and each signal channel; front-face shield-grounding to the din-rail; removable label inserts; easy access front mounted module disconnects; and laser-etched identification and schematic information.

PAC I/O communicates natively on the EtherCAT bus and is unencumbered by protocol converters; therefore it provides the full functionality and throughput of high-speed EtherCAT to meet the most demanding I/O requirements.



PAC I/O Modules

Module Type	Part Number	PACIO Description
Bus Coupler	PACIO-400-00	PACIO EtherCAT Bus coupler, 3 A
Digital I/O Modules	PACIO-450-02	PACIO DI16/DO8 (16 inputs/8 outputs), 1 A
	PACIO-450-03	PACIO DI16/DO16 (16 inputs/16 outputs), 1 ms delay, 0.5 A
	PACIO-450-13	PACIO DI16/DO16 (16 inputs/16 outputs), 1 ms delay, 0.5 A Low-side
	PACIO-451-02	PACIO DI32 (32 inputs), 1 ms delay
	PACIO-451-03	PACIO DI16 (16 inputs), 1 ms delay
	PACIO-450-05	PACIO DI8/DO8 (8 inputs/8 outputs), 1 ms delay, 0.5 A
	PACIO-452-01	PACIO DO16 (16 outputs), 0.5 A
	PACIO-452-02	PACIO DO8 (8 outputs) 1 A
Analog	PACIO-441-01	PACIO AI4-mA (4 single-ended analog input module), 12 Bit resolution
	PACIO-441-02	PACIO AI4/8-VDC (4 differential/8 single-ended analog input module), 13 Bit
	PACIO-442-02	PACIO AO4-VDC/mA (4 analog output module), 12 Bit resolution
Temperature	PACIO-443-01	PACIO AI4-Pt/Ni100 (4 analog inputs, 70 to 300 ohm resistance), 16 Bit
	PACIO-443-03	PACIO AI4-Pt/Ni1000 (4 analog inputs, 70 to 3000 ohm resistance), 16 Bit
Counter	PACIO-454-01	PACIO Counter/Enc (encoder counter module)
Interfaces	PACIO-455-03	PACIO Profibus DP Slave Module
	PACIO-400-02	PACIO Extender 2 Port (EtherCAT I/O extender)
Accessories	PACIO-412-01	PACIO Shield 2x8 mm
	PACIO-412-02	PACIO Shield 14 mm
	PACIO-411-00	Power Distribution Module (distributes 0 VDC or 24 VDC)

Parker Automation Controller - PAC

PAC I/O Specifications

Fieldbus	EtherCAT 100Mb/s
Dimensions	25mm x 120mm x 90mm (W x H x D)
Housing Mount	Aluminum
Shield	Front face of module housing thru to DIN rail
Installation	35mm DIN rail (top-hat rail)
I/O Connection	Spring-assisted combi-plug terminal w/ mechanical ejector, 4...36-pin
Signal Indication	LEDs: located next to the signal's terminal connection
Diagnosis	LEDs: bus state, module state, broken wire/excessive current
Number of Channels	Up to 32 digital I/Os on every module, up to 8 analog channels per module
Supply Voltage	24 VDC -20%/+25%
Number of I/O Modules	20 local and then 20 per bus coupler (total max. power consumption per station: 3A)
Density	Up to 32 digital I/Os per module; up to 8 analog channels per module
Electrical installation	Modules electrically insulated from one another and from the bus
Storage Temperature	-25°C ... + 70°C
Operating Temperature	0°C ... +50°C
Relative Humidity	5% ... 95% non-condensing
Protection	IP20
Noise Immunity	Zone B, EN 61131-2, earth grounded DIN rail in earth grounded cabinet
CE Compliance	2004/108/EC Electromagnetic Compatibility
UL	UL508
RoHS	RoHS Compliant

Accessories and Options

Communication Options

The Parker Automation Controller (PAC) employs the industry leading EtherCAT communication protocol for motion, I/O, and 3rd party device connectivity. Along with EtherCAT, each unit also comes standard with Modbus TCP, an OPC Server, and dual LANs for network separation.

To compliment the standard protocols, the PAC provides options for Ethernet/IP, Profinet, and Profibus, and therefore the PAC can integrate directly into Ethernet/IP and Profinet

networks for machine-to-machine communication.



PROFINET communication module

- **EtherCAT**
- **Ethernet/IP**
- **Profinet**
- **Profibus**
- **Modbus TCP**
- **OPC Server**
- **Dual LANs**

Parker Automation Controller - PAC

Parker Automation Manager IDE

Smart and powerful, Parker Automation Manager is the single integrated development environment for programming complex logic, multi-axis motion, signal handling, and web-published visualizations.

With Automation Manager, engineers can leverage their existing knowledge and work smarter, more efficient and more effective than ever with the full suite of IEC 61131-3 programming languages, PCLopen Motion Control, Parts I and II, and g-code conforming to the DIN66025 standard. This standards-based approach provides a common platform for control engineers and flattens the learning curve, thus saving OEMs time and money.

IEC61131-3 Programming

- Ladder Diagram
- Structured Text
- Continuous Function Chart
- Function Block Diagram
- Sequential Function Chart
- Instruction List

PCLopen Motion Control I & II
DIN 66025 G-code

The common platform approach is complemented by a powerful simulation engine for logic and motion that allows for faster development and by a complete suite of debugging tools, including powerflow; inline variable forcing, watch, and trending; system logging; and breakpoints for logic analysis.

Automation Manager supports reusable, extensible software; object-oriented programming techniques; and even custom library creation for libraries that

can be deployed as compiled—and optionally licensed—code and deployed to protect the

Simulation Runtime Debugging

- Variable Forcing and/or Setting
- Multiple Watch Windows
- Trending
- Powerflow
- Breakpoints

System Logger
Extensible Software
Object-oriented Programming
Custom Libraries

Intellectual Property (IP) of OEMs.

Engineers can now manage an entire product line in one project by including multiple hardware configurations and deploying the appropriate reusable software packages to specific application containers. This method allows OEMs to maintain their program files in one project and make code changes in one place to affect all versions of a particular machine. Thus machine builders now have a development platform specifically designed to support modular machines and valuable add-on software modules.

Customizable Interface

- Cam Editor (Graphical & Tabular)
- G-code Editor (Graphical & Tabular)
- Auto Declaration & Completion
- Recipe Manager
- Alarm Configuration
- Unit Conversions
- Web-published Visualization
- Custom Functions/FBs
- CNC Development
- DXF Import to Dev. Env.
- NC File Import to Runtime

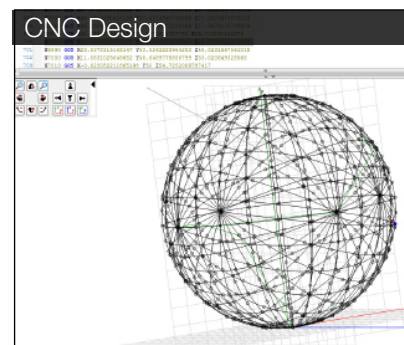
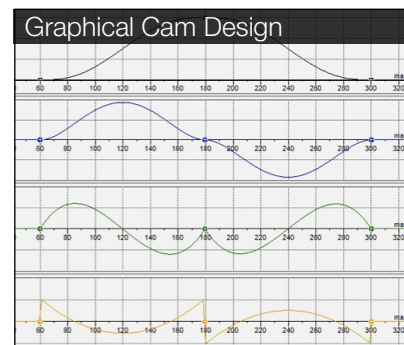
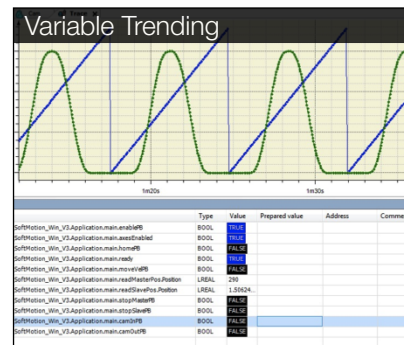
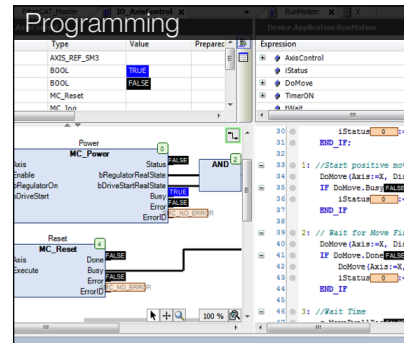

Parker Automation Controller - PAC

Dimensions

PAC Controller

Inches (mm)

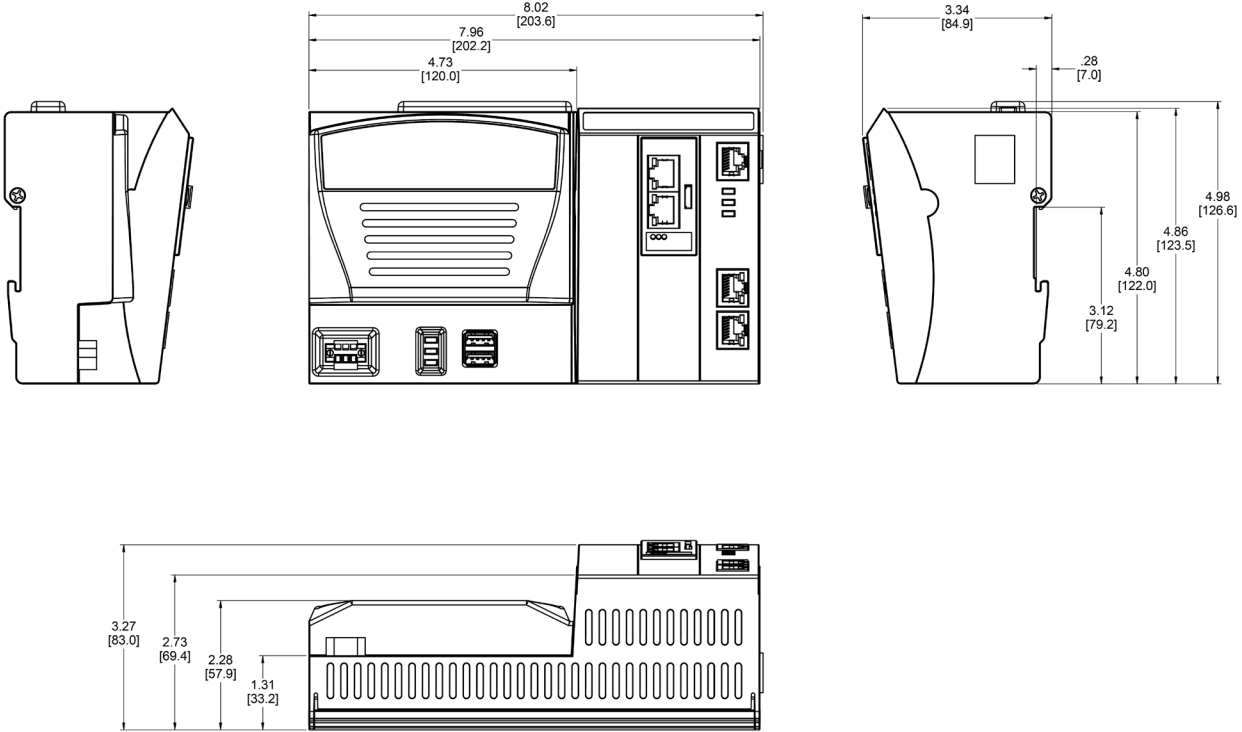

I/O Modules

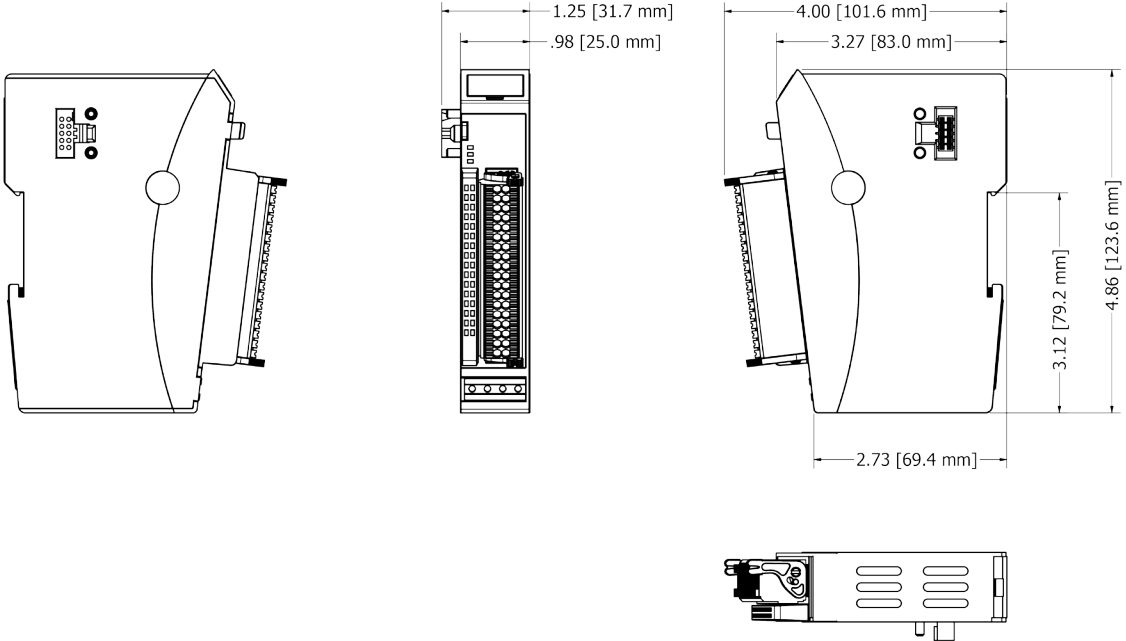

Network Architecture

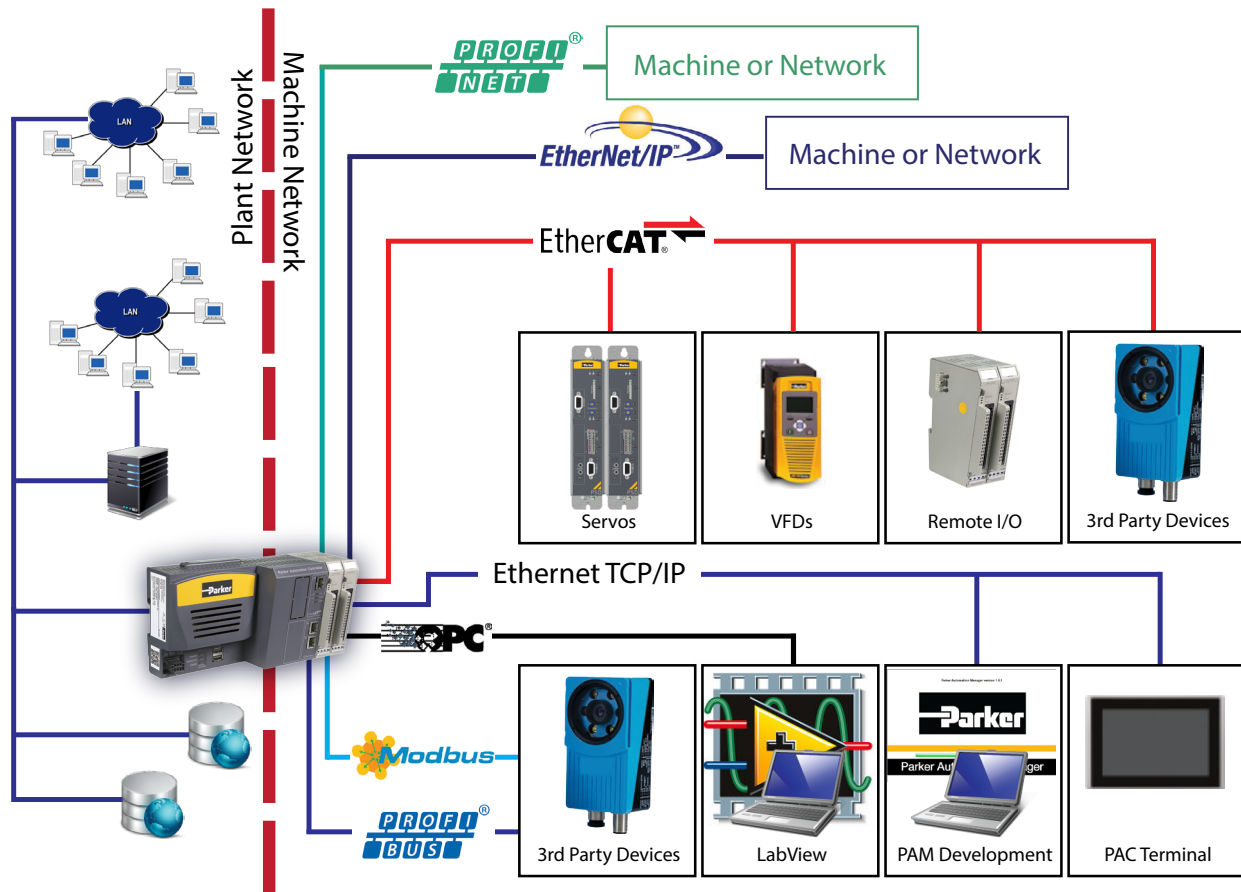

Ordering Information

	①	②	③	④	⑤	⑥	⑦	⑧		
Order Example:	PAC320	-	M	W	N	2	1	-	3	A

Select an option from each numbered field to create a complete model order code.

- | | |
|---|--|
| <p>① Series
 PAC320 Controller</p> <p>② Software
 P IEC only
 M IEC, PLCopen Motion
 C IEC, PLCopen Motion, CNC</p> <p>③ Visualization
 X Embedded Xpress Web-visualization
 W Web-visualization for CNC</p> <p>④ Communication Options
 N No Interface
 E Ethernet/IP
 P Profinet Device
 B Ethernet/IP, PROFINET Device</p> | <p>⑤ Retentive Memory
 2 256k Bytes</p> <p>⑥ Processor
 1 1.60 GHz Dual Core Intel® N2600</p> <p>⑦ Agency Approvals
 3 UL/cUL/CE</p> <p>⑧ Reserved
 A Reserved</p> |
|---|--|

Other Parker Automation Solutions

ETT - Electric Tubular Motors

Parker's rod style linear actuators are offered with either a screw or tubular linear motor drive train, and are available in a variety of strokes. Having the flexibility between these two drive trains



give OEM's the flexibility to either select an actuator which will deliver high speed and acceleration or an actuator that will deliver thrust which rivals that of traditional fluid power actuators. Given this versatility Parker's rod style actuators can be found in applications ranging from semi-conductor, food processing, entertainment, and traditional machine tool.

HMR - High Moment Rodless

Parker Hannifin offers a wide breadth of high moment rodless linear actuators which are driven with a screw, belt or linear motor. In addition to a wide variety of drive train technologies, these

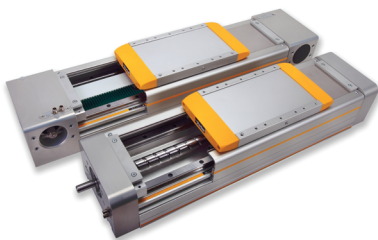

actuators are also offered with a vast array of bearing technologies to suit the needs of the application. Any of these actuator's can be

configured into a multi-axis robotic system, which provides for cost effective automation across industries, including life sciences, semi-conductor, electronics assembly, and automated test or assembly.

MPP/MPE Servo Motors

The MPP Series of brushless servo motors features a segmented lamination design that provides for a very high torque-to-inertia ratio resulting in the highest acceleration rates of any Parker

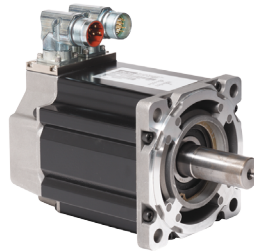

motor. MPPs also include high-performance Neodymium magnets, a potted stator design for thermal efficiency, and multiple feedback options. MPP motor s are available in 92, 100, 115, 142, 190, and 270 mm frame sizes with peak torque ratings up to 402 Nm.

Xpress HMI

Xpress HMI is Parker's award winning web-published HMI

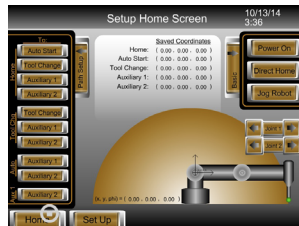

product for interfacing not only Parker's Automation Controller, but also third-party controllers

to the world. With it's intuitive design interface, numerous drag-and-drop objects, and dozens of built-in drivers, Xpress is combines a powerful graphics interface with an intuitive design environment for quick development and an award winning machine front-end.

Compax3 EtherCAT Servo Drives

Compax3 servo drives combine a high-performance, digital design with industrial ruggedness and



expansive power capabilities. Designed specifically for industrial applications with heavy duty features such as built-in regeneration capabilities and AC input line filtering, the wide variety of power levels--up to 155 A RMS--ensures that no application is too large for the Compax3 family.

IPS Structural Aluminum

IPS is a complete line of structural aluminum and linear motion



extrusions created to build innovative solutions in machine building, safety guarding, workstations, and other unlimited industrial applications.



Motion & Control Technologies...

At Parker, we're guided by a relentless drive to help our customers become more productive and achieve higher levels of profitability by engineering the best systems for their requirements. It means looking at customer applications from many angles to find new ways to create value. Whatever the motion and control technology need, Parker has the experience, breadth of product and global reach to consistently deliver. No company knows more about motion and control technology than Parker. For further information call:

1 800 C-Parker
(1 800 272 7537)



Aerospace

Key Markets
Aftermarket services
Commercial transports
Engines
General & business aviation
Helicopters
Launch vehicles
Military aircraft
Missiles
Power generation
Regional transports
Unmanned aerial vehicles

Key Products

Control systems & actuation products
Engine systems & components
Fluid conveyance systems & components
Fluid metering, delivery & atomization devices
Fuel systems & components
Fuel tank inerting systems
Hydraulic systems & components
Thermal management
Wheels & brakes



Climate Control

Key Markets
Agriculture
Air conditioning
Construction Machinery
Food & beverage
Industrial machinery
Life sciences
Oil & gas
Precision cooling
Process
Refrigeration
Transportation

Key Products

Accumulators
Advanced actuators
CO₂ controls
Electronic controllers
Filter driers
Hand shut-off valves
Heat exchangers
Hose & fittings
Pressure regulating valves
Refrigerant distributors
Safety relief valves
Smart pumps
Solenoid valves
Thermostatic expansion valves



Electromechanical

Key Markets
Aerospace
Factory automation
Life science & medical
Machine tools
Packaging machinery
Paper machinery
Plastics machinery & converting
Primary metals
Semiconductor & electronics
Textile
Wire & cable

Key Products

AC/DC drives & systems
Electric actuators, gantry robots & slides
Electrohydraulic actuation systems
Electromechanical actuation systems
Human machine interface
Linear motors
Stepper motors, servo motors, drives & controls
Structural extrusions



Filtration

Key Markets
Aerospace
Food & beverage
Industrial plant & equipment
Life sciences
Marine
Mobile equipment
Oil & gas
Power generation & renewable energy
Process
Transportation
Water Purification

Key Products

Analytical gas generators
Compressed air filters & dryers
Engine air, coolant, fuel & oil filtration systems
Fluid condition monitoring systems
Hydraulic & lubrication filters
Hydrogen, nitrogen & zero air generators
Instrumentation filters
Membrane & fiber filters
Microfiltration
Sterile air filtration
Water desalination & purification filters & systems



Fluid & Gas Handling

Key Markets
Aerial lift
Agriculture
Bulk chemical handling
Construction machinery
Food & beverage
Fuel & gas delivery
Industrial machinery
Life sciences
Marine
Mining
Mobile
Oil & gas
Renewable energy
Transportation

Key Products

Check valves
Connectors for low pressure fluid conveyance
Deep sea umbilicals
Diagnostic equipment
Hose couplings
Industrial hose
Mooring systems & power cables
PTFE hose & tubing
Quick couplings
Rubber & thermoplastic hose
Tube fittings & adapters
Tubing & plastic fittings



Hydraulics

Key Markets
Aerial lift
Agriculture
Alternative energy
Construction machinery
Forestry
Industrial machinery
Machine tools
Marine
Material handling
Mining
Oil & gas
Power generation
Refuse vehicles
Renewable energy
Truck hydraulics
Turf equipment

Key Products

Accumulators
Cartridge valves
Electrohydraulic actuators
Human machine interfaces
Hybrid drives
Hydraulic cylinders
Hydraulic motors & pumps
Hydraulic systems
Hydraulic valves & controls
Hydrostatic steering
Integrated hydraulic circuits
Power take-offs
Power units
Rotary actuators
Sensors



Pneumatics

Key Markets
Aerospace
Conveyor & material handling
Factory automation
Life science & medical
Machine tools
Packaging machinery
Transportation & automotive

Key Products

Air preparation
Brass fittings & valves
Manifolds
Pneumatic accessories
Pneumatic actuators & grippers
Pneumatic valves & controls
Quick disconnects
Rotary actuators
Rubber & thermoplastic hose & couplings
Structural extrusions
Thermoplastic tubing & fittings
Vacuum generators, cups & sensors



Process Control

Key Markets
Alternative fuels
Biopharmaceuticals
Chemical & refining
Food & beverage
Marine & shipbuilding
Medical & dental
Microelectronics
Nuclear Power
Offshore oil exploration
Oil & gas
Pharmaceuticals
Power generation
Pulp & paper
Steel
Water/wastewater

Key Products

Analytical Instruments
Analytical sample conditioning products & systems
Chemical injection fittings & valves
Fluoropolymer chemical delivery fittings, valves & pumps
High purity gas delivery fittings, valves, regulators & digital flow controllers
Industrial mass flow meters/ controllers
Permanent no-weld tube fittings
Precision industrial regulators & flow controllers
Process control double block & bleeds
Process control fittings, valves, regulators & manifold valves



Sealing & Shielding

Key Markets
Aerospace
Chemical processing
Consumer
Fluid power
General industrial
Information technology
Life sciences
Microelectronics
Military
Oil & gas
Power generation
Renewable energy
Telecommunications
Transportation

Key Products

Dynamic seals
Elastomeric o-rings
Electro-medical instrument design & assembly
EMI shielding
Extruded & precision-cut, fabricated elastomeric seals
High temperature metal seals
Homogeneous & inserted elastomeric shapes
Medical device fabrication & assembly
Metal & plastic retained composite seals
Shielded optical windows
Silicone tubing & extrusions
Thermal management
Vibration dampening

EM Sales Offices

Australia

Parker Hannifin (Australia) Pty Ltd.
9 Carrington Road
Castle Hill NSW 2154
Australia
Tel: +61 (0) 2 9634-7777
Fax: +61 (0) 2 9634 3749

Brazil

Parker Hannifin Ind. Com Ltda.
Av. Lucas Nogueira Garcez 2181
Esperança
12325-900 Jacareí, SP
Tel: 12 3954 5100
Fax: 12 3954 5262
Email: automation.brazil@parker.com

Canada

Parker Hannifin (Canada) Inc.
160 Chisholm Dr
Milton, Ontario L9T 3G9
Tel: 905-693-3000
Fax: 905-876-1958
Email: miltoncustservice@parker.com

China

Parker Hannifin Motion & Control
(Shanghai) Co., Ltd
280 Yunqiao Rd. Jin Qiao Export
Processing Zone
Shanghai 201206, China
Tel: (86-21) 50312525
Fax: (86-21) 64459717

France

Parker SSD Parvex
8 avenue du Lac
B.P. 249
F-21007 Dijon Cedex
Tel: +33 (0) 3 80 42 41 40
Fax: +33 (0) 3 80 42 41 23

Germany

Electromechanical Europe
Parker Hannifin GmbH & Co KG
Robert-Bosch-Strasse 22
D-77656 Offenburg
Germany
Tel: +49 (0) 781 509 0
Fax: +49 (0) 781 509 98176
Email: em-motion@parker.com

India

Parker Hannifin India Pvt. Ltd
Automation Group-SSD Drives Div.
133 & 151 Developed Plots Estate
Perungudi, Chennai 600 096
Tel: 044-4391-0799
Fax: 044-4391-0700

Italy

Parker Hannifin SpA
Via Gounod 1
20092 Cinsello Balsamo
Milano, Italy
Tel: +39 02 361081
Fax: +39 02 36108400
Email: em-motion@parker.com

Korea

Parker Hannifin Korea
9th Floor KAMCO Yangjae Tower
949-3 Dogok 1-dong Gangnam-gu
Seoul 135-860, Korea
Tel: 82-2-559-0454
Fax: 82-2-556-8187

Mexico

Parker Hannifin de Mexico
Eje uno Norte No.100
Parque Industrial Toluca 2000
Toluca, CP 50100 México
Tel: 52-722-275-4200
Fax: 52-722-279-0316

Singapore

Parker Hannifin Singapore Pte Ltd
11, Fourth Chin Bee Road
Singapore 619702
Tel: (65) 6887 6300
Fax: (65) 6265 5125/6261 4929

Taiwan

Parker Hannifin Taiwan Co., Ltd
No. 40, Wuchiuan 3rd Road
Wuku Industrial Park
Taipei County, Taiwan 248
ROC
Tel: 886 2 2298 8987
Fax: 886 2 2298 8982

Thailand

Parker Hannifin (Thailand) Co., Ltd.
1265 Rama 9 Road
Suanluang, Bangkok 10250
Thailand
Tel: (66) 2 186 7000
Fax: (66) 2 374 1645

UK

Parker Hannifin Ltd.
Tachbrook Park Drive
Tachbrook Park
Warwick CV34 6TU
Tel: +44 (0) 1926 317970
Fax: +44 (0) 1926 317980

USA

Parker Hannifin Electromechanical
Automation Division Main Office
5500 Business Park Drive
Rohnert Park, CA 94928 USA
Tel: 707-584-7558
800-358-9070
Fax: 707-584-8015
Email: emn_support@parker.com

Parker Hannifin Electromechanical
Automation Division
1140 Sandy Hill Road
Irwin, PA 15642
Tel: 724-861-8200
800-245-6903
Fax: 724-861-3330
Email: emn_support@parker.com

